



KAR SERIES

KAR 1000V1

OWNER'S MANUAL

LIMITED WARRANTY

Before shipping this product back for service call for a Return Authorization number. This number must be clearly marked on the outside of the box.

Terms & Conditions: ARC Audio warrants this unit to be free of any material defects or defects in workmanship for a period of one year and will repair, replace or replace with remanufactured goods, at its discretion, this unit or any part thereof, only if it proves to be defective as a result of normal use.

Our obligation under this warranty is limited to the defective components of the unit thereof when it is returned, shipping prepaid, to ARC Audio.

This warranty is to be considered void if the unit has been tampered with, connected contrary to the installation instructions in the owner's manual, altered, damaged by improper input voltages or polarity, defaced, or treated in a negligent manner.

All returns must be sent freight prepaid and must be accompanied by proof of purchase or they will be treated as "OUT of WARRANTY" and will only be repaired at the owner's expense. All warranties, expressed or implied, shall be void if the serial is removed or defaced.

Out of warranty service is available after the warranty expires. Cost of repair is based on current repair labor rates, plus the cost of shipping and handling. When returning for repair, pack the unit securely and send prepaid and insured to the address below. ARC Audio is not responsible for damage incurred during shipping.

For warranty and non-warranty repairs, send to:

**ARC Audio
4719 Green Leaf Cr. #4
Modesto CA, 95356
209-543-8706**



www.arcaudio.com

Congratulations!

Thank you for purchasing an ARC Audio Hi-Performance Amplifier.

ARC Audio amplifiers are conservatively rated and produce more power per channel than others in their class. Manufactured to the highest standards of quality and reliability to deliver years of listening enjoyment.

ARC Audio...**SOLID CONSTRUCTION for SOUND Car Audio Systems.**

Warning

We build all ARC Audio products to play at high volumes for extended periods of time. Your ears however are not designed for high volume listening. This product can easily generate volumes that can permanently damage your hearing. We urge you to limit your exposure to very high volume sound.

You may also find your state has laws governing the volume of an audio system in a car. Please be aware of all local and state laws in your area.

A properly tuned and operated audio system will deliver years of enjoyment when used properly.

Installation Instructions

ARC Audio KAR Series Amplifiers are designed for easy installation in your vehicle. To ensure proper operation of your new purchase, please follow the suggestions we have listed below:

Warning

Please check the suitability of the installation location before you begin. Do not cut any of the car's structure. Pay close attention to what is behind the panels or carpet. Often the manufacture will hide wires, computers or other electronic devices in the exact areas you wish to install in.

If you do not have experience with automotive electrical and mechanical systems contact a professional installer. Paying a qualified installer is almost always cheaper than paying a dealership to repair your car.

Locating the Amplifier

The amplifiers must be securely mounted to a solid surface. Please select a dry location in the trunk or passenger compartment only. Do not mount the amplifier to any area that may have excess vibration (like the subwoofer box). Position the amplifier in an area that receives sufficient airflow for proper heat dissipation.

Supplying Enough Power

The Laws of Nature

Your amplifier Does NOT make power. It converts power, or current, from your car's electrical system and turns it into a high power musical energy. If the amp can't get all the power it needs it will not produce its full output. Your ARC Audio amplifier will produce Full output for longer than other amps on the market today. If the Voltage or Current drops too low even our amplifiers will drop below their rated output. Make sure your vehicle charging system is in good working order. Any Hi-Performance audio amplifier will increase the demand on your alternator and battery. If you are unsure have your charging system tested by a professional technician.

The Ground!!!

Warning: Read this Carefully

The ground wire should be connected directly to the chassis of your vehicle. Find a clear location close to the amplifier and remove all the paint and sound deadener. Use a #10 or larger screw to secure it. Never use seatbelt bolts for grounding.

Remember, the ground must carry the same high current as the positive power wire.

To reduce the risk of noise, run all signal cables away from any vehicle or power supply wiring.

Running the Cables

Carefully run the power and signal cables through the passenger compartment of the vehicle.

Always use a rubber grommet to prevent the power wire from shorting and to reduce the risk of fire.

An 4 gauge or larger wire should be used for power and ground connections. We recommend a fuse be installed on the power wire within 18 inches of the battery for safety.

Setting the Gains

So you're worried that your 4 Volt output head unit will be too much for the ARC Audio's 2.5 Volt input stage.

Don't Be

ARC Audio Amplifiers input stage is rated to 2.5 volts RMS @ 1KHz without clipping.

Music is very dynamic. Nothing like a 1KHz test tone. It would be rare to see a peak as high as a test tone. Furthermore, your head unit produces its output at full volume but when you tune your system you always set the head unit to 70% of maximum volume.

Input Section

Because of the wide range of head unit output configurations all ARC Audio amplifiers have an adjustable input sensitivity or "Gain". The gain is not a volume or a power limiting control like a throttle. It makes the amp more sensitive to input from the stereo. With the gain up the amp will reach full output at a lower volume setting on the deck. At higher gain settings the amp also becomes more sensitive to noise from the car's electrical system. Try to run the gain at the lowest setting possible for you system.

There is no correct gain setting. Because speakers require different power demands to reach the same output, the gains most often need to be used to compensate for these differences. If you tried to set all the gains at half way you would probably find the system didn't sound very good. Using good judgment and listening carefully to each speaker is still the best way to tune a system.

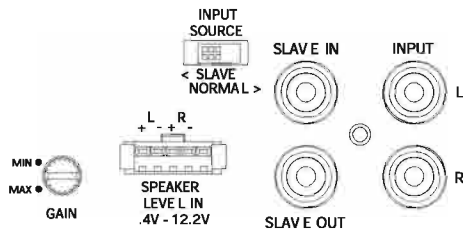

Crossover Controls

A crossover is a device that removes unwanted frequencies from a speaker or amplifier. A tweeter can easily be destroyed by bass notes if they are not filtered out. Likewise a subwoofer will not sound natural if it is playing midrange notes. A crossover removes these sounds from the speaker. As you might guess, careful adjustment is need to ensure that all the speakers are playing the right sounds and that you are left with no "holes" or low spots in the frequency response.

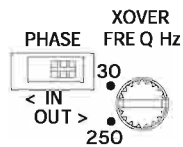

Bass Boost

This amp has a fully adjustable bass boost. Both the frequency and the level of the boost are adjustable. Start with a small increase in the level control. Then "sweep" the frequency up and down. Listen carefully for an improvement in the sound of the bass. If you do not hear any improvement then the woofer does not need any boost.

Use Bass Boost carefully. The demands on power output are tremendous. Try to minimize the use by changing woofer position or the enclosure size.

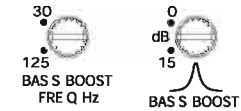

Subsonic Filter

A subsonic filter acts like a crossover but at very low frequencies. It removes sound that is so low the speaker cannot reproduce it. You see the cone moving but hear no sound. This can be very hard on your woofer especially at high power. If you are using a ported subwoofer enclosure at high power you should use a Subsonic Filter to limit cone movement at very low frequencies.



Speaker outputs

This amplifier is a mono design. Meaning it has only 1 channel. It is equipped with a single large block terminal for speaker connection. Make this connection carefully and neatly. If the wires ever come in contact with each other the amp will go into protection.

Know your total ohm load before you make any connections.

Note the ohm load switch. Use the 2 ohm position for any load over 2 ohms. For any load under 2 ohms switch to the 1 ohm mode.

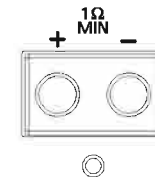

Bridging

Bridging is a way to combine the power of 2 channels into 1. When you wire the amp bridged you have a higher voltage differential between + and -. That means MORE POWER.

If you have 2 identical, properly designed mono amplifiers (They can not be a stereo amp that is bridged internally) you can bridge them together to create 1 channel.

1. Run a jumper wire between the negative (-) speaker output of the 2 amps. Use the same gauge speaker wire you used to connect the speaker.



2. Run a speaker wire from amplifier 1 (Normal) positive (+) output to the woofer +.

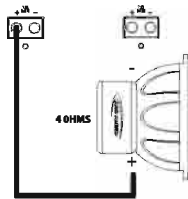

3. Run a speaker wire from amplifier 2 (Slave) positive (+) output to the woofer -.

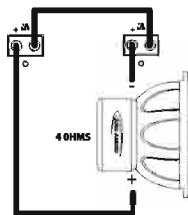
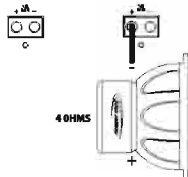

When you are finished it should look like this.

Warning

When bridging any amp or amps, each channel sees half the ohm load. 4 ohms bridged is the same as 2 ohms stereo. 1 ohm bridged is equal to 1/2 ohm stereo. Check the compatibility of you woofers and amplifier before you begin.

Bridging Cont.

For bridging to work both amplifiers must be playing exactly the same signal at exactly the same output level. To make this easier we have added a "Slave In" and "Slave Out" to this amp. When you use the Slave In all the gain and crossovers are bypassed. This eliminates all the complicated tuning needed to match each amp.

When bridging 2 amp, 1 amp will act as the positive output and the other will act as the negative output. The negative amp will need to play "out of phase" from the positive amp. Imagine it like this. The positive amp is pushing the woofer and the negative amp is pulling. You can do this by changing the "Phase" switch to "OUT"

Please see the switch setting below.

Amp 1 (NORMAL)

Set the load switch to the correct location for your woofers.

4 ohm bridged set to TWO
2 ohm bridged set to ONE

Set the phase to "IN"

Run a mono RCA cable to "SLAVE OUT"

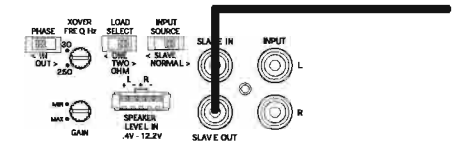

Amp 2 (SLAVE)

Set the load switch to the correct location for your woofers.

4 ohm bridged set to TWO
2 ohm bridged set to ONE

Set the phase to "OUT"

Run a mono RCA cable to "SLAVE IN"

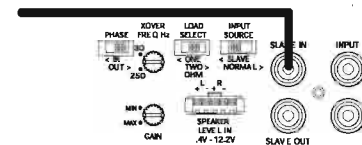

Installation Instructions

1. Disconnect the negative cable from the car battery. Tape up the end so it is isolated from the battery.
2. Run the power wire (4 AWG min.) from the battery to the amplifier. Plan this part of the installation carefully. This cable will carry very high current. If it should short to the body and it is not properly fused it could catch fire.
3. Connect the power wire to the battery using a fuse capable of the total current load of all amplifiers connected. Don't install the fuse yet. Wait until the end. Locate the fuse as close as possible to the battery. If the fuse is further than 18 inches (wire length) from the battery you should reevaluate the wire and fuse placement.
4. Find the closest clear metal area to the amp for a ground. Sand, grind or scrape all paint and undercoating from the body and screw the ground securely to the body.

It is advisable to test the ground with an ohmmeter between the ground cable and the negative battery cable to insure a good low resistance connection. Some alloys used in modern cars do not offer the best ground. If you believe this is the case consult with the vehicle manufacturer.

5. Run the speaker wire to the speakers. It is advised that you leave some extra wire at this point. You can "clean it up" later.
6. If you haven't already done so, mount the amp now.
7. Connect the power and ground to the amplifier.

Only after this step should you install the fuse at the battery.

8. Connect the remote wire from the head unit to the amplifier. Now is a good time to turn on the amp for the first time. Make sure it turns on properly and does not go into protect.

9. Connect the speaker wire to the amp and speakers (make sure the amp is off first). Make sure the polarity (+ and-) is correct.
10. Connect the RCA's to the amp.
11. Double check the amplifier controls at this time. Make sure everything is set correctly for your system.
12. Now you're ready to play it for the first time. It is best to leave the gain all the way down at first. Start with the head unit volume low and work your way up.
13. Now you can tune the amp. Take your time and make only one adjustment at a time. It may take some time to get the system fully adjusted. During this time the amp is drawing current from the battery. You should check the battery voltage from time to time and re-charge it if it gets low. Battery voltage can affect the way the amplifier performs.
14. You're done. Now have fun.

2 OHM OPERATION

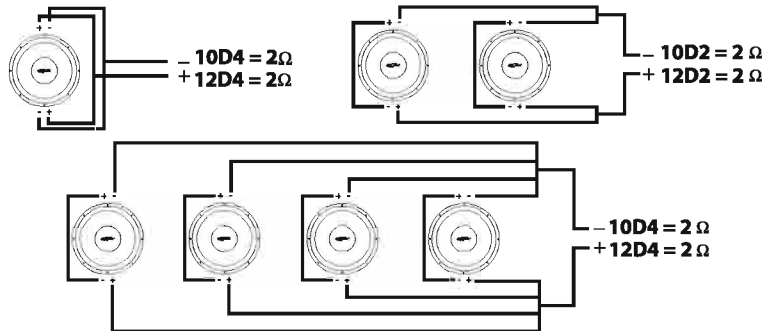
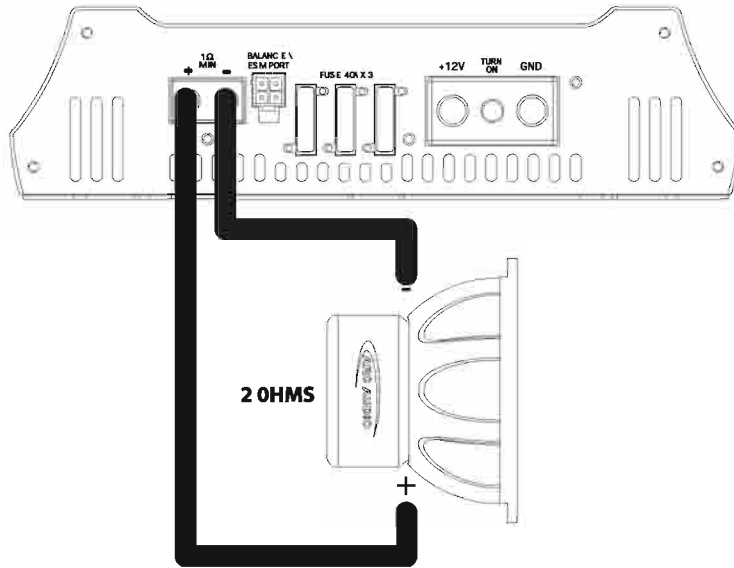
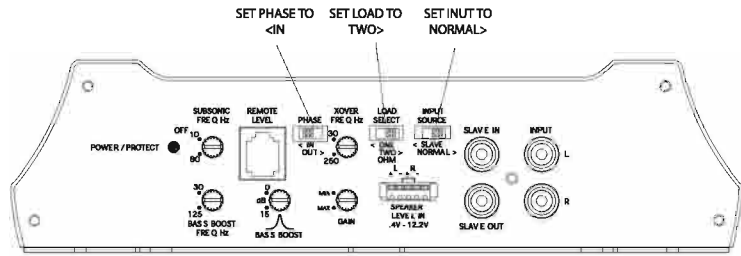

1 OHM OPERATION

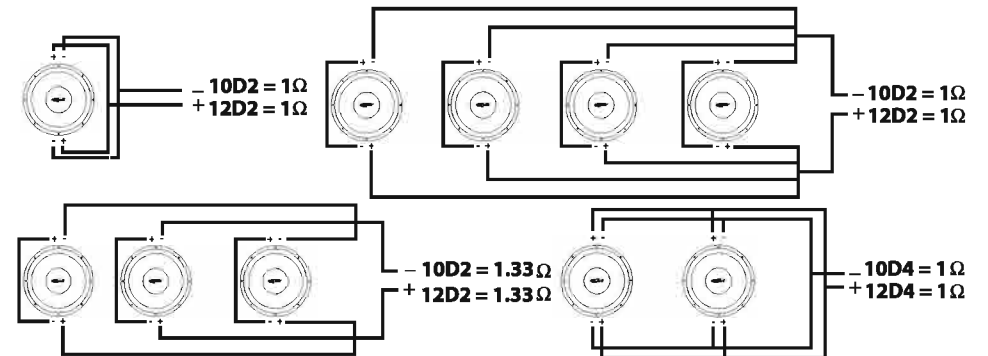
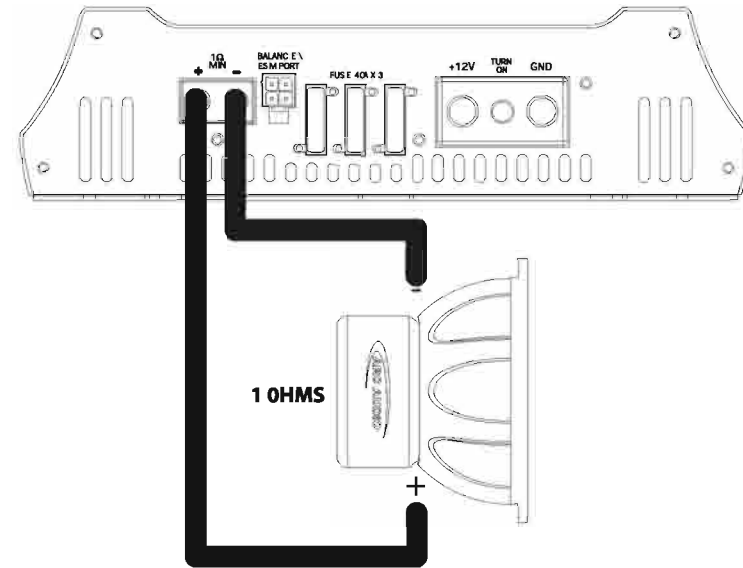
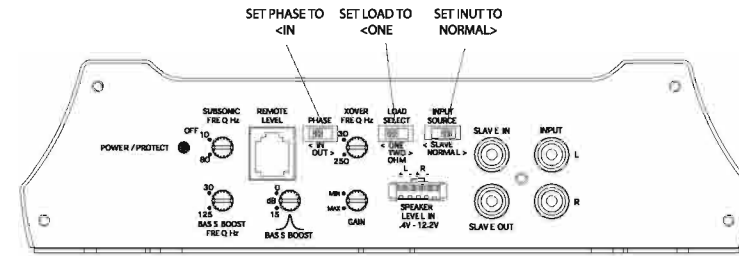

4 OHMS BRIDGED

In this configuration you can "Bridge" 2 amplifiers into 1 channel. To bridge 2 amps you must set amp 1 to "Normal" and amp 2 to "Slave". All adjustments will then be made to amp 1. Amp 2 will need no further adjustments

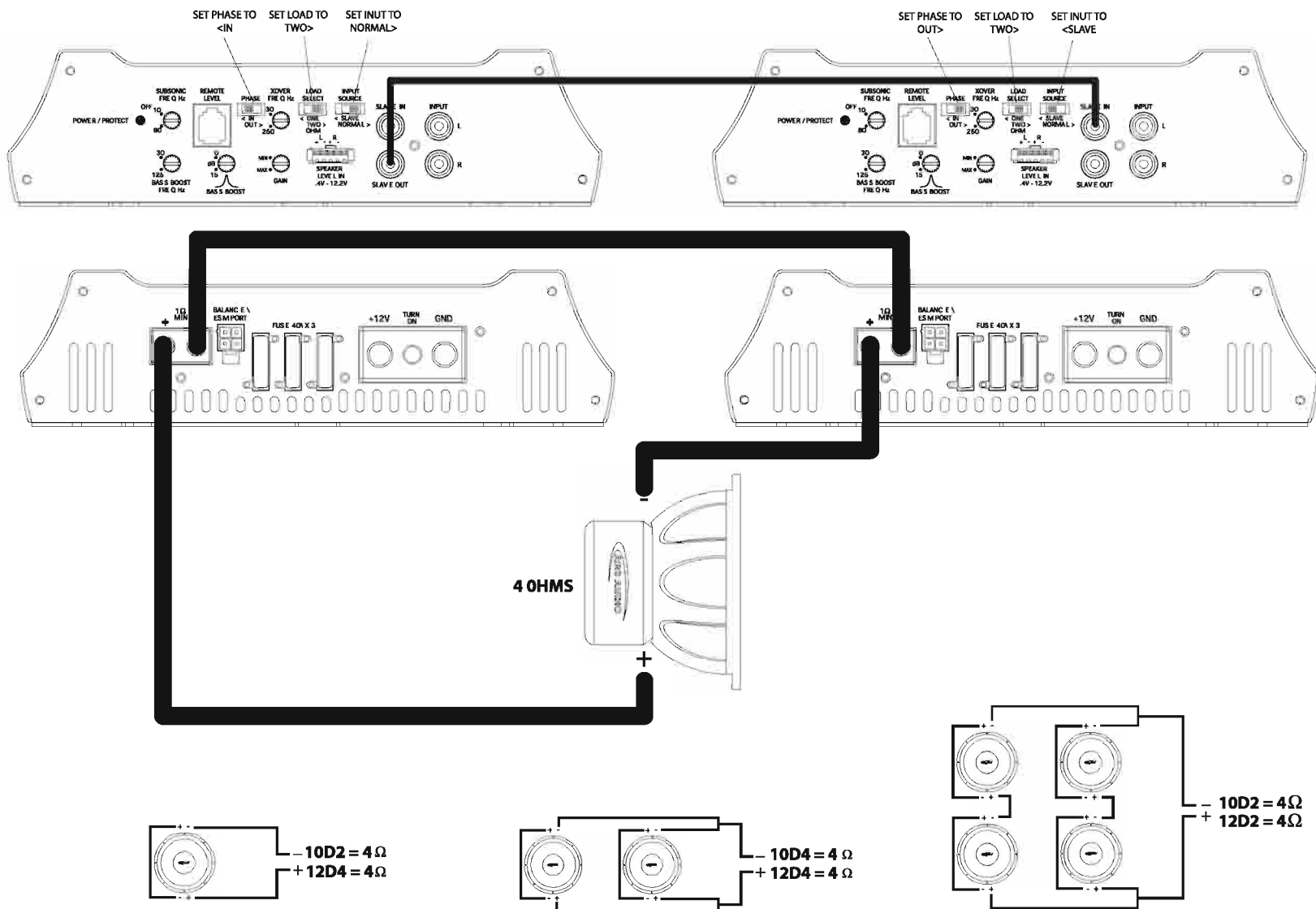

2 OHMS BRIDGED

In this configuration you can "Bridge" 2 amplifiers into 1 channel. To bridge 2 amps you must set amp 1 to "Normal" and amp 2 to "Slave". All adjustments will then be made to amp 1. Amp 2 will need no further adjustments

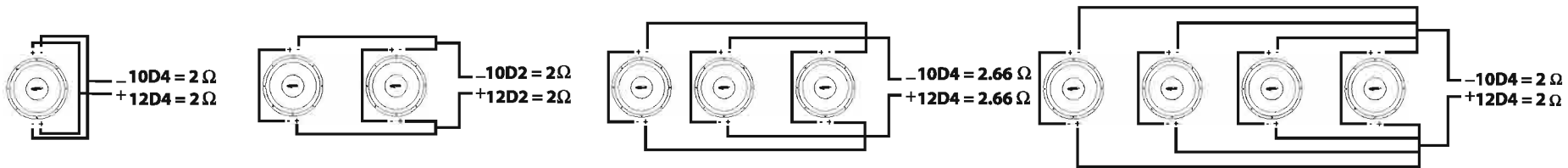
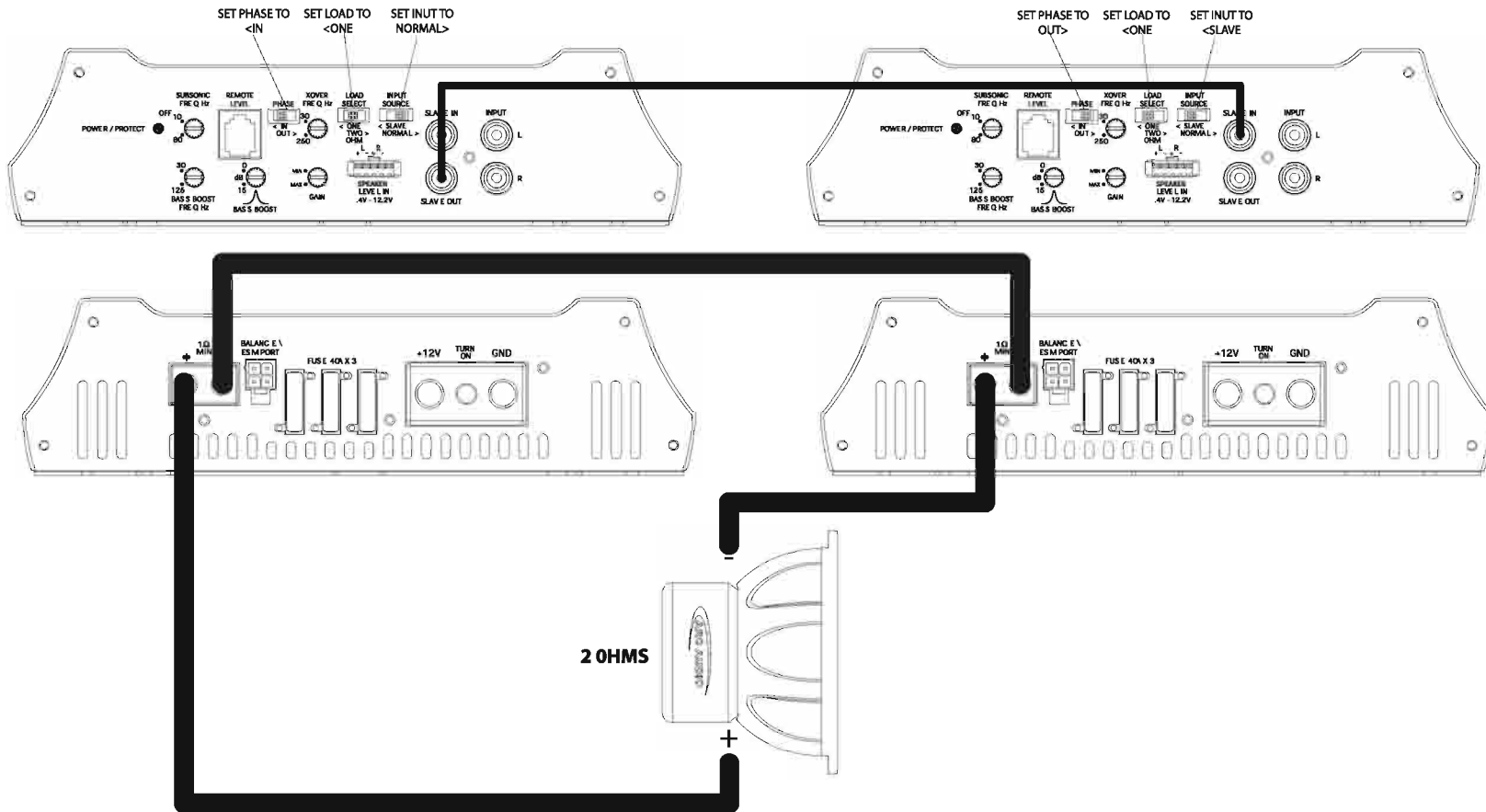

POWER AND INPUT CONNECTIONS

DUAL BATTERY or BATTERY AND CAPACITOR

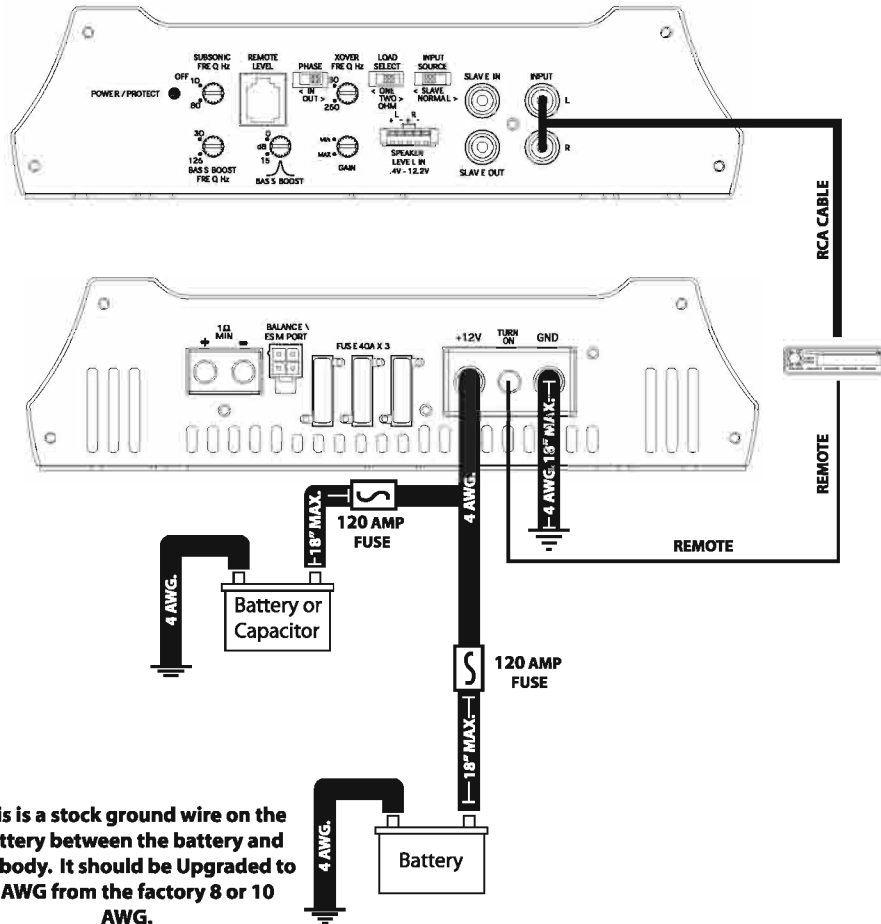

POWER AND INPUT CONNECTIONS

SINGLE BATTERY

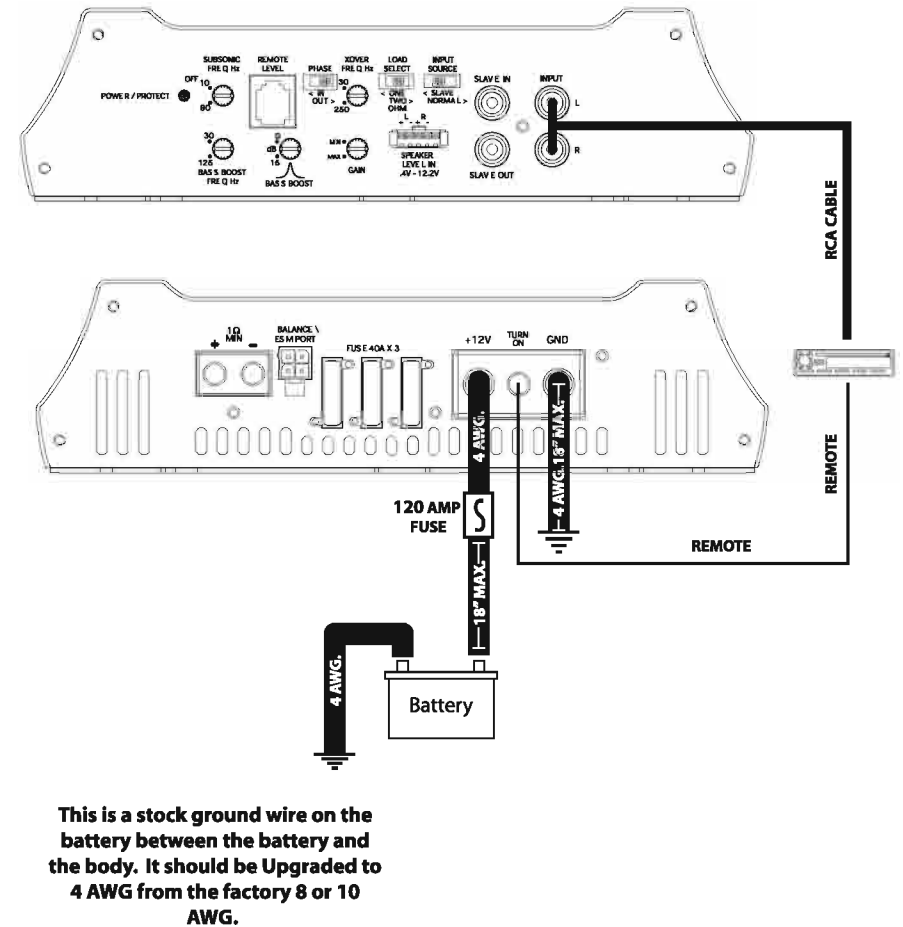

Specifications

Output Power (RMS) @ .2% THD 1Khz
 Mono @ 40hms 50 Amps 510 Watts
 Mono @ 20hms 102 Amps 1000 Watts
 Mono @ 10hm 120 Amps 1000 Watts

T.H.D. @ 1Khz @ 400 Watts
 40hm < .006%
 20hm < .005%
 10hm < .006%

Frequency Response +/- .3dB 20Hz - 250Hz

S/N Ration (A wtg.) >112 dB
 Speration @ 1kHz 2.5V in NA
 Crossover Range 30Hz - 250Hz

Input Sensitivity .2V - 8V

High Level Input Sensitivity .4V - 16V

Bass Boost 0 - 15dB @ 30Hz - 125Hz

Input Impedance
 Low Level (RCA) 12K ohms
 High Level 392 ohms

Max Peak Current 110A @ 1100 Watts (2 ohms)
 Idle Current 1.7A no Fan 1.8A with Fan
 Efficiency 65% @ 1000 Watts (2 ohms)
 Damping 100 Watts 40hms > 2100
 Slew 52V/ μ Sec

