

XDi 850.5

Full Range Class D Amplifier

Introduction	1
Finding a Suitable Location	1
Supplying Power	1
The Ground	1
Running the Cables	2
Class D amplifiers	2
Diagnostic Fault Codes	2
Controls and Features	
Inputs	3
Gains	3
Crossovers	3
Remote Level Control	3
Bass Boost	4
Ohm Load Matching	4
Speaker Outputs	4
Installation Instructions	5
System Diagrams	
5 Channel - Stereo W/Sub	6
Auto Detect	7
Speaker Level Input	7
Specifications	8
Warranty	8

Crossover and Gain Controls

To access the crossover controls, mounting tabs or power connection on all XDi models you will need to remove the top cover. This is done by removing the 4 screws securing the logo plate using a 5/32" Allen key or driver bit. Once this is done, gently lift straight up on the top cover. You may find a little resistance. This is a tight fit but with a little effort it will lift off. The majority of the controls can then be easily accessed.

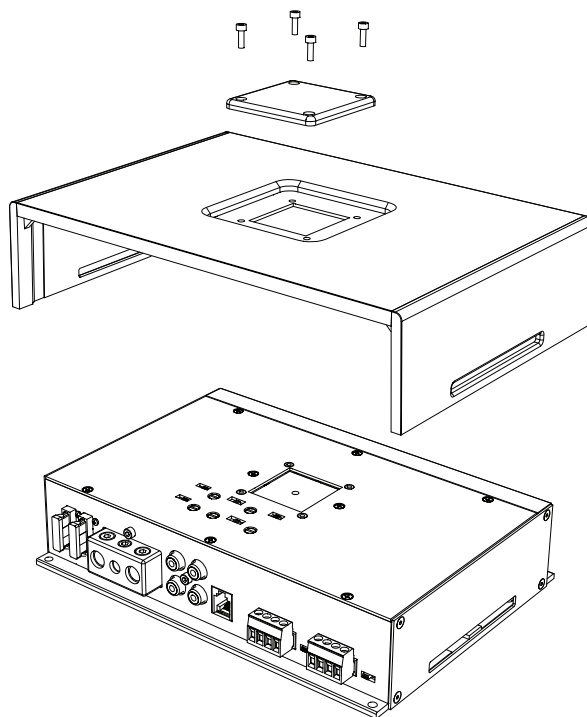

Thank you for purchasing an ARC Audio Hi-Performance Amplifier.

This ARC Audio amplifier uses a Full Range Class D architecture that significantly improves efficiency, lowers heat output and current draw. Don't be fooled by the small size. Class D amplifiers make more power for their size than traditional designs making installation a breeze without compromising storage space.

ARC Audio...**SOLID CONSTRUCTION for SOUND Car Audio Systems.**

Warning

We build all ARC Audio products to play at high volumes for extended periods of time. Your ears however are not designed for high volume listening. This product can easily generate volumes that can permanently damage your hearing. We urge you to limit your exposure to very high volume sound.

You may also find your state has laws governing the volume of an audio system in a car. Please be aware of all local and state laws in your area.

A properly tuned and operated audio system will deliver years of enjoyment when used properly.

Installation Instructions

ARC Audio XDi Amplifiers are designed for easy installation in your vehicle. To ensure proper operation of your new purchase, please follow the suggestions we have listed below:

Warning

Please check the suitability of the installation location before you begin. Do not cut any of the car's structure. Pay close attention to what is behind the panels or carpet. Often the manufacture will hide wires, computers or other electronic devices in the exact areas you wish to install in.

If you do not have experience with automotive electrical and mechanical systems contact a professional installer. Paying a qualified installer is almost always cheaper than paying a dealership to repair your car.

Locating the Amplifier

The amplifiers must be securely mounted to a solid surface. Please select a dry location in the trunk or passenger compartment only. Do not mount the amplifier to any area that may have excessive vibration (like the subwoofer box). Position the amplifier in an area that receives sufficient airflow for proper heat dissipation.

Supplying Enough Power

The Laws of Nature

Your amplifier Does NOT make power. It converts power, or current, from your car's electrical system and turns it into a high power musical energy. If the amp can't get all the power it needs it will not produce its full output. Your ARC Audio amplifier will produce Full output for longer than other amps on the market today. If the Voltage or Current drops too low even our amplifiers will drop below their rated output. Make sure your vehicle charging system is in good working order. Any Hi-Performance audio amplifier will increase the demand on your alternator and battery. If you are unsure have your charging system tested by a professional technician.

The Ground!!!

Warning: Read this Carefully

The ground wire should be connected directly to the chassis of your vehicle. Find a clear location close to the amplifier and remove all the paint and sound deadener. Use a #10 or larger screw to secure it. A nut, bolt and lock washer would be better still. Never use seat belt bolts for grounding.

Remember, the ground must carry the same high current as the positive power wire.

To reduce the risk of noise, run all signal cables away from any vehicle or power supply wiring.

Running the Cables

Carefully run the power and signal cables through the passenger compartment of the vehicle. Running power down one side and signal down the other is the preferred method. If this isn't possible, keep them separated as much as possible. When running through any metal, always use a rubber grommet to prevent the power wire from shorting and to reduce the risk of fire. A 4 gauge or larger wire should be used for power and ground connections. ALWAYS install a fuse on the power wire within 18 inches of the battery for safety.

Recommendations for all Class D amplifiers

Class D amplifiers by the nature of their design emit a certain amount of RF (Radio Frequency) radiation. While we have optimized the design to reduce this to a minimum level there are still steps you can take to eliminate any unwanted FM radio interference. The tips below apply to any class D amplifier.

Always mount the amplifier as far from the antenna as the installation will allow. At the same time you will want to keep it away from the radio or any other electronics that may prove to be sensitive to FR radiation.

Make the ground wire as short as possible. Think of the ground like it is an antenna. Short antennas do not work as well.

Use twisted pair wires as much as possible. If you can manage it all the speaker wire and input cable weather by RCA or speaker level should be twisted. If you do not have twisted pair wire you may be able to twist it yourself.

If you encounter a problem with FM interference you can try turning the amplifier 90 degrees or changing its location completely. RF radiation can be very directional.

Warning

Take extra care when using CCA (Copper Clad Aluminum) or pure aluminum wire to insure the connections as clean and tight. Do to aluminums highly reactive nature these connections can fail without the typical "Green" or tarnished look you would expect with copper. Aluminum also has a greater rate of expansion do to heat and care must be taken to insure that the connection is not over tightened. This can result in the failure of the power or ground connector and possibly the circuit board.

DIAGNOSTIC FAULT CODES

Thermal (Heatsink) The Amplifier has Over Heated. Turn the volume down and let it cool off.	
Thermal (Transformer) The Power Supply Transformer has Over Heated. Turn the volume down and let it cool off.	
Code 11 Under Voltage The Battery Voltage is too low. I bet your car won't start. If it does, you have a bad connection.	
Code 12 Short (Low Power Channel) Shorted speaker or wire on Channels 1-4. Turn the system off until you can get this fault corrected. Also includes internal shorts.	
Code 13 Repeated Shorts You didn't turn the system off, did you?	
Code 14 Over Voltage Your Alternator is Over-Charging. Have your vehicle's electrical system tested right away.	
Code 15 DC Output Protection DC Current was detected on the speaker line and to avoid damaging the speakers, this amplifier has shut down. This will probably require factory service.	
Code 16 Short (High Power Channel) Shorted speaker or wire on subwoofer channels (5 or 5-6) also includes internal shorts.	
Normal Turn on Blue is good. This is normal self test and turn on delay.	
Power/Processor Reset You will see this the first time the amplifier is powered up or the microprocessor resets. This code will vary from model to model.	

Input Section

This XDi amplifier is equipped with a Balanced Input Stage that is compatible with any analog source including Balanced and Unbalanced RCA, Common ground speaker level output or BTL (Bridged Tied Load) outputs common on many OEM headunits. The RCA pigtailed included with this amplifier are intended to be used to speaker level outputs and include a divider network molded into the end to reduce the level of the OEM system. **If you are integrating into an OEM system balanced or common ground line level signal you should not use these Pigtailed.** In this case it is recommended that you use an appropriate RCA cable with 1 set of ends removed as inputs for the amplifier.

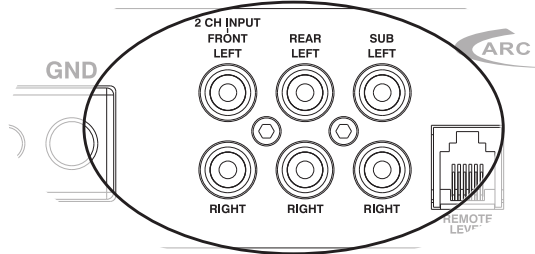

Gain

Because of the wide range of head unit output configurations all ARC Audio amplifiers have an adjustable input sensitivity or "Gain". The gain is not a volume or a power limiting control like a throttle. It makes the amp more sensitive to input from the stereo. With the gain up the amp will reach full output at a lower volume setting on the deck. At higher gain settings the amp also becomes more sensitive to noise from the car's electrical system. Try to run the gain at the lowest setting possible for your system.

There is no correct gain setting. Because speakers require different power demands to reach the same output, the gains most often need to be used to compensate for these differences. If you tried to set all the gains at half way you would probably find the system didn't sound very good. Using good judgment and listening carefully to each speaker is still the best way to tune a system.

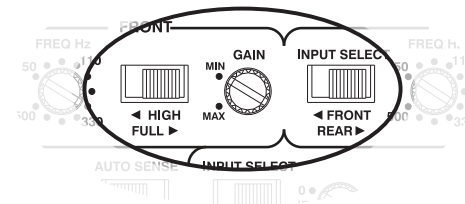

Crossover Controls

A crossover is a device that removes unwanted frequencies from a speaker or amplifier. A tweeter can easily be destroyed by bass notes if they are not filtered out. Likewise a subwoofer will not sound natural if it is playing midrange notes. A crossover removes these sounds from the speaker. As you might guess, careful adjustment is needed to ensure that all the speakers are playing the right sounds and that you are left with no "holes" or low spots in the frequency response.

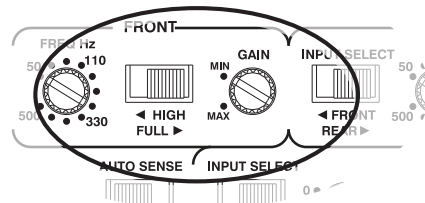

Remote Level Control

This amplifier is equipped with the LOWPASS crossover. It **DOES NOT** work in highpass or full range. This control has the effect of reducing the gain by -12dB. To use this control set the gains to the maximum (**SAFE and undistorted**) volume you would use. The remote is then used to adjust this level down to a normal level. It will not mute these channels completely.

This **Does Not** control the Bass Boost.

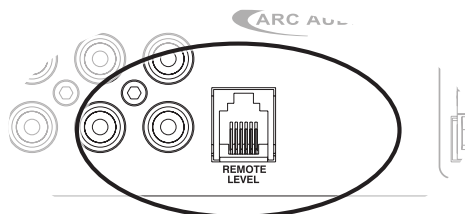

Bass Boost

This amp has an adjustable bass boost. The frequency is fixed at 45Hz. The level of the boost can be adjusted up to 12dB. Start with a small increase in the level control. then “sweep” the frequency up and down. Listen carefully for an improvement in the sound of the bass. If you do not hear any improvement then the woofer does not need any boost.

WARNING: Use Bass Boost carefully. The demands on power output are tremendous. Try to minimize the use by changing woofer position or the enclosure size.

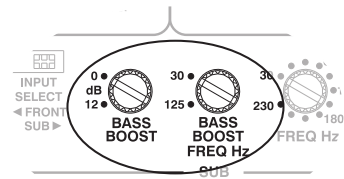

Ohm Loads

This amplifier operates in the traditional sense with regard to Ohm loads. Lowering the Ohm load will increase power output however it will also increase current draw and produce more heat. This amplifier is capable of running any mix or combination of Ohm load on the front and rear channels. They do not have to be the same.

Any speaker or combination of speakers with a total combine Ohm load between 2 and 4 Ohms can be used on any single channel.

Bridged loads **must not drop below 4 ohms** but may exceed 8 Ohms if needed. This will not damage the amplifier however power output will decrease at higher load.

WARNING: This amplifier will not operate and could be damaged if used in the wrong configuration. At no time can it be operated below 2 Ohms stereo or 4 Ohms bridged.

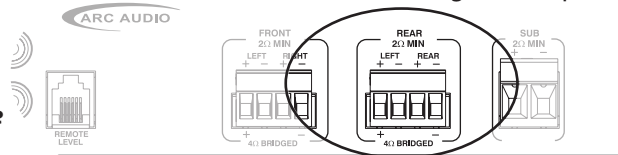

Speaker outputs

This amplifier is a multi channel amplifier design. Meaning it has more than one channel of speaker outputs. It is equipped with a removable plug style terminal for speaker wire connections up to 14 AWG. Make this connection carefully and neatly. Strip your wire back 5/16” and twist the exposed leads and insert them into the block terminal while being careful that there is no loose or frayed strands of wire. Tighten the standard head screw down on the terminal until the wire is tightly secured in place. If the wires ever come in contact with each other the amplifier will go into protection.

Know your total ohm load before you make any connections.

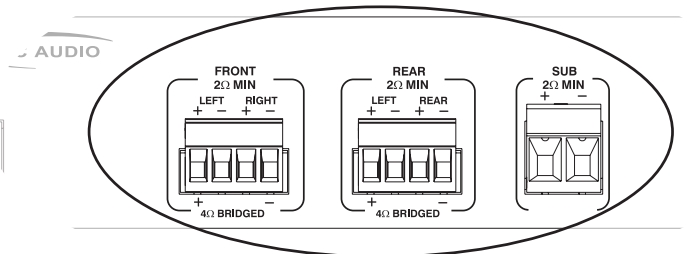

Strip Speaker Wire

Installation Instructions

Below is a very abbreviated set of installation instructions. This is not meant as a step by step procedure but is intended to give you a general idea of what is involved and which steps come first. Every installation will be different and may require reordering of these steps. NEVER install the fuse at the battery or connect the negative battery cable until all your connections are final.

Before you start, disconnect the negative cable from any batteries in the car. Tape up the end so it is isolated from the battery.

Run an appropriate gauge wire from the battery to the amplifier. Plan this part of the installation carefully. This cable will carry very high current. If it should short to the body and it is not properly fused it could catch fire. **You DID use a grommet when you ran it through the firewall, didn't you?**

Connect the power wire to the battery using a fuse capable of the total current load of all amplifiers connected. **Don't install the fuse yet.** Wait until the end. Locate the fuse as close as possible to the battery. If the fuse is further than 18 inches (wire length) from the battery, you should reevaluate the wire and fuse placement.

Find the closest clear metal area to the amp for a ground. Sand, grind or scrape all paint and undercoating from the body and screw the ground securely in place. A nut, bolt and lock washer is advisable here.

It is advisable to test the ground with an Ohmmeter between the ground cable and the negative battery cable to insure a good low resistance connection. Some alloys used in modern cars do not offer the best ground. If you believe this is the case, consult with the vehicle's manufacturer.

Run the speaker wire to the speakers. It is advised that you leave some extra wire at this point. You can "clean it up" later.

If you haven't already done so, mount the amp now.

Connect the power and ground to the amplifier.

Only after this step should you install the fuse at the battery.

Connect the remote wire from the head unit to the amplifier. Now is a good time to turn on the amp for the first time. Make sure it turns on properly and does not go into protection.

Connect the speaker wires to the amp and speakers (make sure the amp is off first). Make sure the polarity (+ and -) is correct.

Connect the RCA signal wires to the amp.

Double check the amplifier controls at this time. Make sure everything is set correctly for your system.

Now you're ready to play it for the first time. It is best to leave the gain all the way down at first. Start with the head unit volume low and work your way up.

Now you can tune the amp. Take your time and make only one adjustment at a time. It may take some time to get the system fully adjusted. During this time the amp is drawing current from the battery. You should check the battery voltage from time to time and re-charge it if it gets low. That's it. You're done. Now have fun.

XDi 850.5

5 CHANNEL STEREO 4 CHANNEL HIGH PASS W/SUB

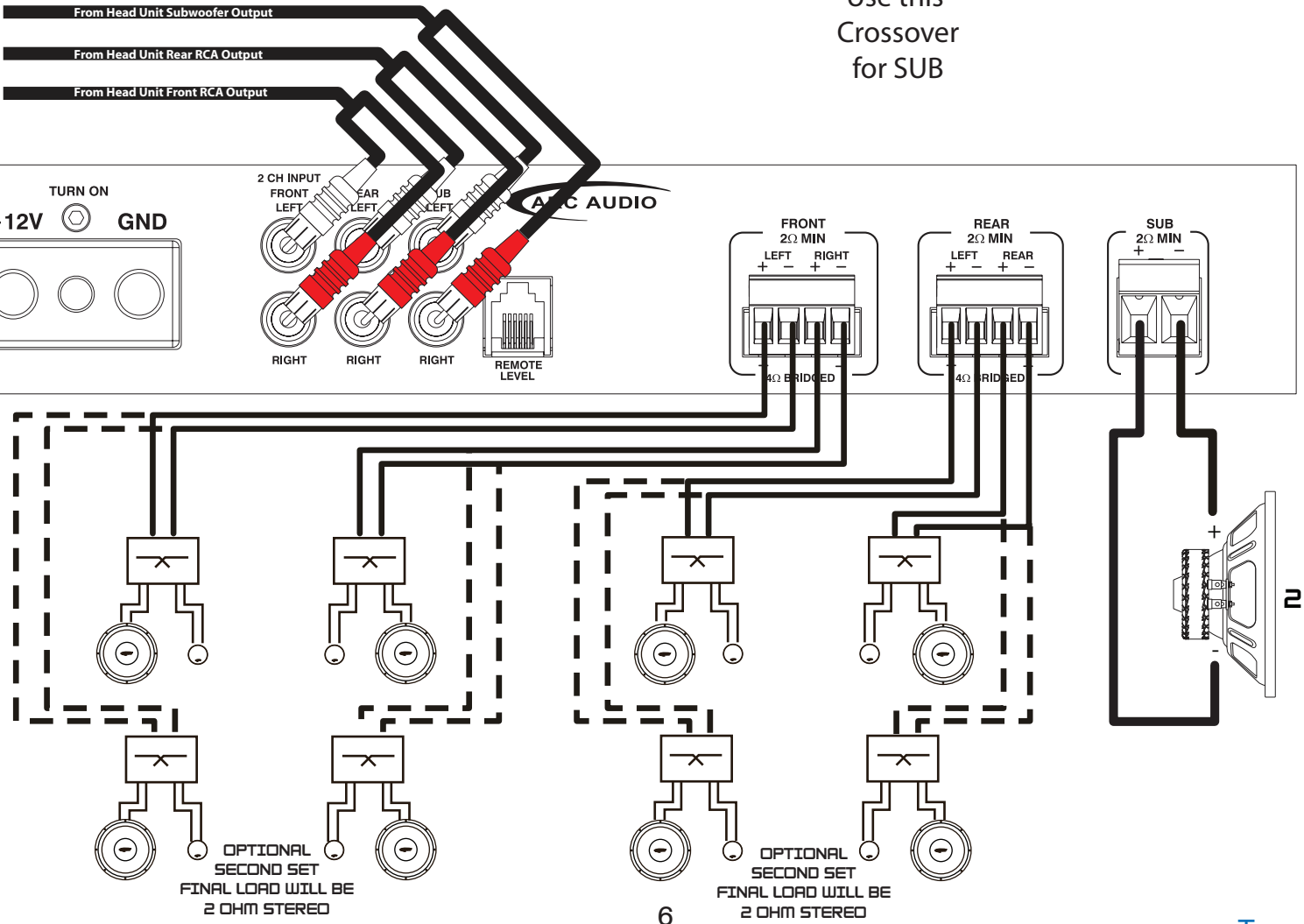
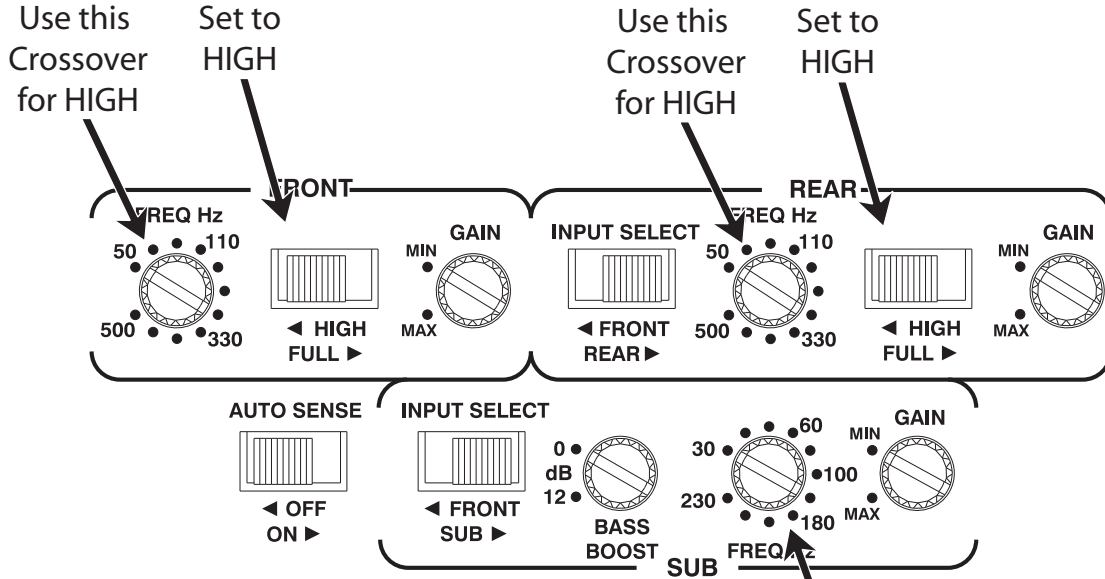

XDi 850.5 AUTO DETECT SPEAKER LEVEL INPUT

AUTO SENSE

The XDi 850.5 uses BTLD (Bridge Tied Load Detect) Turn-on circuit that offers a significant improvement in reliability over previous designs. Instead of relying on the music to supply enough signal to turn the amplifier on, Robert Zeff's design detects the IC (chip) used in the vast majority of stock head units and amplifiers.

Note: There is not trouble shooting required for this method. No AUTO SENSE will work with every system. If AUTO SENSE does not work perfectly the first time it is recommended that you find an alternative remote trigger immediately.

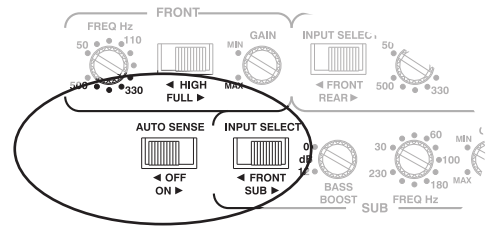

All XDi amplifiers have inputs capable of 4 Volts however many OEM systems are capable of 8 Volts of output. The supplied RCA "Pigtails" include a 2:1 voltage divider molded into the connector. When used they increase the input voltage range to 8 Volts.

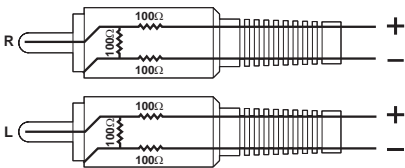

If the extra voltage range is not needed any twisted pair RCA can be easily modified by removing 1 end.

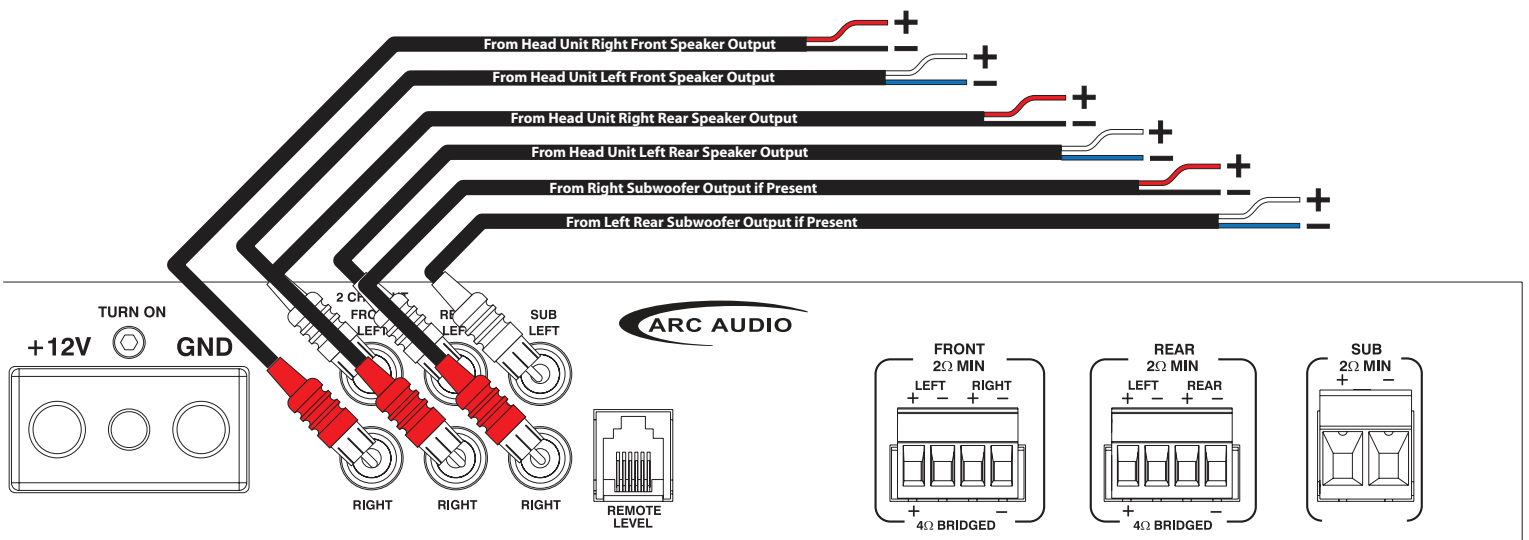
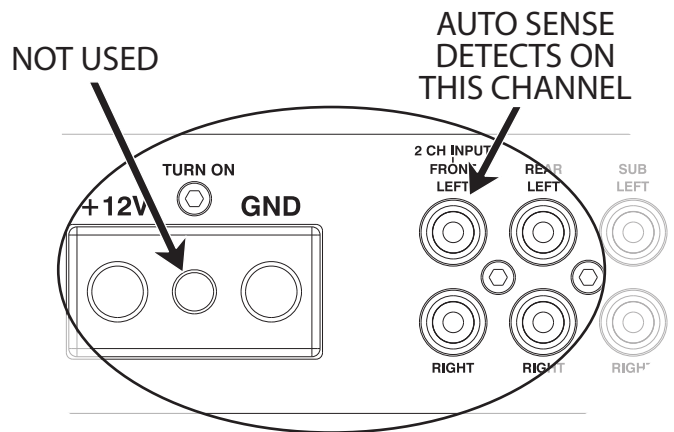

SPECIFICATIONS

FOUR CHANNEL AMPLIFIERS

	<i>XDi 450.4</i>	<i>XDi 600.4</i>
4 Channels @ 4 ohms-	85 Watts	150 Watts
4 Channels @ 2 ohms-	125 Watts	150 Watts
2 Channel @ 4 ohms-	250 Watts	300 Watts
Frequency Response-	20Hz - 20kHz	20Hz - 20kHz
Total Harmonic Distortion	.08% THD	.02% THD
Bass Boost-	12dB @45Hz ^(Rear only)	12dB@45Hz ^(Front Only)
Remote Included-	No	Yes
XDi Trim Kit-	Not Included	Included
Dimensions-	8.173" (L) x 6.268" (W) x 2.086" (H)	9.020" (L) x 6.268" (W) x 2.162" (H)

FIVE CHANNEL AMPLIFIERS

	<i>XDi850.5</i>	<i>XDi1100.5</i>
4 Channels @ 4 ohms-	85 Watts	150 Watts
4 Channels @ 2 ohms-	125 Watts	150 Watts
2 Channel @ 4 ohms-	250 Watts	300 Watts
1 Channel @ 4 ohms-	225 Watts ^(Sub Channel)	275 Watts ^(Sub Channel)
1 Channel @ 2 ohms-	400 Watts ^(Sub Channel)	500 Watts ^(Sub Channel)
Frequency Response-	20Hz - 20kHz	20Hz - 20kHz
Frequency Response ^{(sub)-}	20Hz - 230Hz	20Hz - 230Hz
Total Harmonic Distortion	.08% THD	.02% THD
Bass Boost ^{(Sub Ch)-}	12dB@45Hz	12dB@45Hz
Remote Included-	Yes	Yes
XDi Trim Kit	Not Included	Included
Dimensions-	12.42" (L) x 6.268" (W) x 2.086" (H)	12.42" (L) x 6.268" (W) x 2.162" (H)

MONO BLOCK AMPLIFIERS

	<i>XDi650.1</i>	<i>XDi1100.1</i>
1 Channels @ 4 ohms-	185 Watts	350 Watts
1 Channels @ 2 ohms-	350 Watts	600 Watts
1 Channel @ 1 ohms-	650 Watts	1100 Watts
Frequency Response-	20Hz - 230Hz	20Hz - 230Hz
Total Harmonic Distortion	.05% THD	.06% THD
Bass Boost-	12dB@30-125Hz	12dB@30-125Hz
Remote Included-	Yes	Yes
XDi Trim Kit-	Not Included	Included
Dimensions-	9.02" (L) x 6.268" (W) x 2.086" (H)	13.0" (L) x 6.268" (W) x 2.162" (H)

SIX CHANNEL AMPLIFIERS

	<i>XDi1200.6</i>
4 Channels @ 4 ohms-	150 Watts
4 Channels @ 2 ohms-	150 Watts
2 Channels @ 4 ohms-	300 Watts
2 Channels @ 4 ohms-	150 Watts (Ch 5&6)
2 Channel @ 2 ohms-	300 Watts (Ch 5&6)
1 Channel @ 4 ohms-	600 Watts (Ch 5&6)
Frequency Response-	20Hz - 20kHz
Total Harmonic Distortion	.02% THD
Bass Boost-	12dB @ 45Hz (Ch 5&6)
Remote Included-	Yes
XDi Trim Kit-	Included
Dimensions-	13.0" (L) x 6.268" (W) x 2.162" (H)

ARC AUDIO WARRANTY

ARC AUDIO warranties all new XDi Amplifiers against defects in material and workmanship for a period of **ONE (1) YEAR** from the original date of purchase. **This warranty is not transferable and applies only to the original retail purchaser of the product from an authorized ARC AUDIO retailer.** Upon inspection by ARC AUDIO should services be necessary under this warranty for any reason due to manufacture defects ARC AUDIO will, at its sole discretion, repair or replace the defective product with new or similar conditioned product at no charge.

THIS WARRANTY DOES NOT COVER INSTALLATION OR DAMAGE RESULTING FROM ACCIDENT, MISUSE, ABUSE, IMPROPER WIRING, OPERATION OUTSIDE OF THE MANUFACTURERS RECOMMENDATIONS OR SPECIFICATIONS, OR AGAINST INSTRUCTIONS IN THE OWNERS MANUAL. IN ADDITION ANY PRODUCT THAT HAS BEEN OPENED, TEMPERED WITH OR MODIFIED, OR IF ANY SERIAL NUMBERS HAVE BEEN REMOVED WILL NOT BE COVERED BY ANY PART OF THE MANUFACTURERS WARRANTY.

All warranty returns should be sent to ARC AUDIO freight prepaid and must be accompanied by proof of purchase (a copy of the original sales receipt). Direct returns from consumers or non-authorized retailers will be refused unless specifically authorized by ARC AUDIO with a valid return authorization number.

All warranty returns should be packed in original packaging and must be accompanied by a copy of the original sales receipt. Product damaged in shipment will not be covered under this warranty. The customer or retailer may choose to have this damage repaired at the normal "Out of Warranty" repair cost.

In no event will ARC AUDIO be liable for incidental, consequential, or other damages resulting from the use of this product, this includes but is not limited to, damage of hearing, property or person, damage based upon inconvenience or on loss of use of the product, and to the extent permitted by law, damages for personal injury. This warranty gives you specific legal rights, and you may have other rights, which vary from state to state. This warranty applies to products sold and used in the United States of America. In all other countries please contact your distributor